



RX-V293

Natural Sound AV Receiver

Récepteur audiovisuel

**OWNER'S MANUAL
MODE D'EMPLOI**

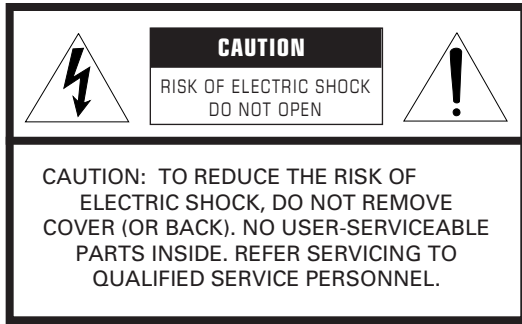

IMPORTANT
Please record the serial number of this unit in the space below.

Model:
Serial No.:

The serial number is located on the rear of the unit.
Retain this Owner's Manual in a safe place for future reference.

• Explanation of Graphical Symbols

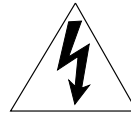

The lightning flash with arrowhead symbol, within an equilateral triangle, is intended to alert you to the presence of uninsulated "dangerous voltage" within the product's enclosure that may be of sufficient magnitude to constitute a risk of electric shock to persons.



The exclamation point within an equilateral triangle is intended to alert you to the presence of important operating and maintenance (servicing) instructions in the literature accompanying the appliance.

WARNING
TO REDUCE THE RISK OF FIRE OR ELECTRIC SHOCK, DO NOT EXPOSE THIS UNIT TO RAIN OR MOISTURE.

SAFETY INSTRUCTIONS

- 1 Read Instructions – All the safety and operating instructions should be read before the unit is operated.
- 2 Retain Instructions – The safety and operating instructions should be retained for future reference.
- 3 Heed Warnings – All warnings on the unit and in the operating instructions should be adhered to.
- 4 Follow Instructions – All operating and other instructions should be followed.
- 5 Water and Moisture – The unit should not be used near water – for example, near a bathtub, washbowl, kitchen sink, laundry tub, in a wet basement, or near a swimming pool, etc.
- 6 Carts and Stands – The unit should be used only with a cart or stand that is recommended by the manufacturer.
- 6A A unit and cart combination should be moved with care. Quick stops, excessive force, and uneven surfaces may cause the unit and cart combination to overturn.
- 7 Wall or Ceiling Mounting – The unit should be mounted to a wall or ceiling only as recommended by the manufacturer.
- 8 Ventilation – The unit should be situated so that its location or position does not interfere with its proper ventilation. For example, the unit should not be situated on a bed, sofa, rug, or similar surface, that may block the ventilation openings; or placed in a built-in installation, such as a bookcase or cabinet that may impede the flow of air through the ventilation openings.
- 9 Heat – The unit should be situated away from heat sources such as radiators, stoves, or other appliances that produce heat.
- 10 Power Sources – The unit should be connected to a power supply only of the type described in the operating instructions or as marked on the unit.
- 11 Power-Cord Protection – Power-supply cords should be routed so that they are not likely to be walked on or pinched by items placed upon or against them, paying particular attention to cords at plugs, convenience receptacles, and the point where they exit from the unit.
- 12 Cleaning – The unit should be cleaned only as recommended by the manufacturer.
- 13 Nonuse Periods – The power cord of the unit should be unplugged from the outlet when left unused for a long period of time.
- 14 Object and Liquid Entry – Care should be taken so that objects do not fall into and liquids are not spilled into the inside of the unit.
- 15 Damage Requiring Service – The unit should be serviced by qualified service personnel when:
 - A. The power-supply cord or the plug has been damaged; or
 - B. Objects have fallen, or liquid has been spilled into the unit; or
 - C. The unit has been exposed to rain; or
 - D. The unit does not appear to operate normally or exhibits a marked change in performance; or
 - E. The unit has been dropped, or the cabinet damaged.
- 16 Servicing – The user should not attempt to service the unit beyond those means described in the operating instructions. All other servicing should be referred to qualified service personnel.
- 17 Power Lines – An outdoor antenna should be located away from power lines.
- 18 Grounding or Polarization – Precautions should be taken so that the grounding or polarization is not defeated.



19 For US customers only:

Outdoor Antenna Grounding – If an outside antenna is connected to this unit, be sure the antenna system is grounded so as to provide some protection against voltage surges and built-up static charges. Article 810 of the National Electrical Code, ANSI/NFPA 70, provides information with regard to proper grounding of the mast and supporting structure, grounding of the lead-in wire to an antenna discharge unit, size of grounding conductors, location of antenna discharge unit, connection to grounding electrodes, and requirements for the grounding electrode.

Note to CATV system installer:

This reminder is provided to call the CATV system installer's attention to Article 820-40 of the NEC that provides guidelines for proper grounding and, in particular, specifies that the cable ground shall be connected to the grounding system of the building, as close to the point of cable entry as practical.

SPECIAL NOTES FOR FCC COMPOSITE DEVICE (for US customers only)

This device is a composite system. The digital device component may not cause harmful interference.

EXAMPLE OF ANTENNA GROUNDING

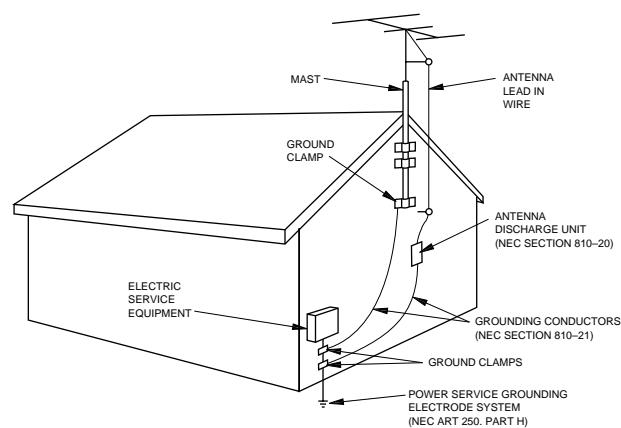

NEC – NATIONAL ELECTRICAL CODE

FCC INFORMATION (for US customers only)**1. IMPORTANT NOTICE : DO NOT MODIFY THIS UNIT!**

This product, when installed as indicated in the instructions contained in this manual, meets FCC requirements. Modifications not expressly approved by Yamaha may void your authority, granted by the FCC, to use the product.

2. IMPORTANT : When connecting this product to accessories and/or another product use only high quality shielded cables. Cable/s supplied with this product MUST be used. Follow all installation instructions. Failure to follow instructions could void your FCC authorization to use this product in the USA.**3. NOTE :** This product has been tested and found to comply with the requirements listed in FCC Regulations, Part 15 for Class "B" digital devices. Compliance with these requirements provides a reasonable level of assurance that your use of this product in a residential environment will not result in harmful interference with other electronic devices.

This equipment generates/uses radio frequencies and, if not installed and used according to the instructions found in the users manual, may cause interference harmful to the operation of other electronic devices.

Compliance with FCC regulations does not guarantee that interference will not occur in all installations. If this product is found to be the source of interference, which can be determined by turning the unit "OFF" and "ON", please try to eliminate the problem by using one of the following measures:

Relocate either this product or the device that is being affected by the interference.

Utilize power outlets that are on different branch (circuit breaker or fuse) circuits or install AC line filter/s.

In the case of radio or TV interference, relocate/reorient the antenna. If the antenna lead-in is 300 ohm ribbon lead, change the lead-in to coaxial type cable.

If these corrective measures do not produce satisfactory results, please contact the local retailer authorized to distribute this type of product. If you can not locate the appropriate retailer, please contact Yamaha Electronics Corp., U.S.A. 6660 Orangethorpe Ave, Buena Park, CA 90620.

The above statements apply ONLY to those products distributed by Yamaha Corporation of America or its subsidiaries.

We Want You Listening For A Lifetime

YAMAHA and the Electronic Industries Association's Consumer Electronics Group want you to get the most out of your equipment by playing it at a safe level. One that lets the sound come through loud and clear without annoying blaring or distortion – and, most importantly, without affecting your sensitive hearing.

Since hearing damage from loud sounds is often undetectable until it is too late, YAMAHA and the Electronic Industries Association's Consumer Electronics Group recommend you to avoid prolonged exposure from excessive volume levels.



CONTENTS

| | |
|---|---|
| SAFETY INSTRUCTIONS.....Inside the Front Cover | CONTROLS AND THEIR FUNCTIONS12 |
| SUPPLIED ACCESSORIES2 | SPEAKER BALANCE ADJUSTMENT16 |
| FEATURES3 | BASIC OPERATIONS18 |
| CAUTION4 | TUNING OPERATIONS20 |
| NOTES ABOUT THE REMOTE CONTROL TRANSMITTER5 | PRESET TUNING21 |
| PROFILE OF THIS UNIT6 | USING DIGITAL SOUND FIELD PROCESSOR (DSP)24 |
| SPEAKER SETUP7 | TROUBLESHOOTING27 |
| CONNECTIONS8 | SPECIFICATIONS28 |

SUPPLIED ACCESSORIES

After unpacking, check that the following parts are included.

- Indoor FM Antenna

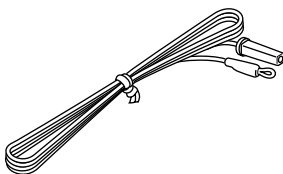

- AM Loop Antenna

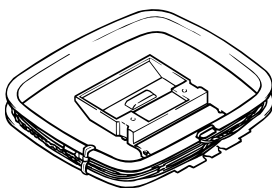

- Antenna adapter (U.S.A. and Canada models only)

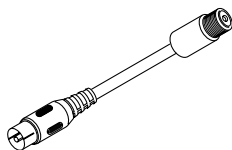

- Remote Control Transmitter

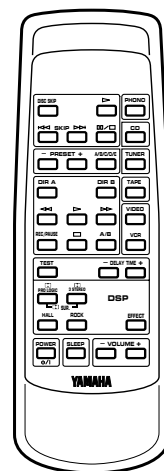

- Batteries (size AA, R6, UM-3)

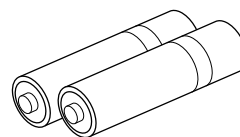

FEATURES

- **5 Speaker Configuration (Power Amp. Section)**
 - Main: 50W + 50W (8Ω) RMS Output Power, 0.04% THD, 20–20,000 Hz**
 - Center: 50W (8Ω) RMS Output Power, 0.04% THD, 1 kHz**
 - Rear: 20W (8Ω) RMS Output Power, 0.04% THD, 1 kHz**
- **Digital Sound Field Processor**
- **Dolby Pro Logic Surround Decoder**
- **Automatic Input Balance Control for Dolby Pro Logic Surround**
- **Test Tone Generator for Easier Speaker Balance Adjustment**
- **3 Center Channel Modes (NORM/WIDE/PHANTOM)**
- **40-Station Random Access Preset Tuning**
- **Automatic Preset Tuning**
- **Preset Station Shifting Capability (Preset Editing)**
- **IF Count Direct PLL Synthesizer Tuning System**
- **Video Signal Input/Output Capability**
- **SLEEP Timer**
- **Remote Control Capability**

CAUTION : READ THIS BEFORE OPERATING YOUR UNIT.

1. To assure the finest performance, please read this manual carefully. Keep it in a safe place for future reference.
2. Install this unit in a cool, dry, clean place – away from windows, heat sources, sources of excessive vibration, dust, moisture and cold. Avoid sources of humming (transformers, motors). To prevent fire or electrical shock, do not expose the unit to rain or water.
3. Never open the cabinet. If something drops into the set, contact your dealer.
4. Do not use force on switches, controls or connection wires. When moving the unit, first disconnect the power plug and the wires connected to other equipment. Never pull the wires themselves.
5. The openings on the cabinet assure proper ventilation of the unit. If these openings are obstructed, the temperature inside the cabinet will rise rapidly. Therefore, avoid placing objects against these openings, and install the unit in well-ventilated condition. Be sure to allow a space of at least 20 cm behind, 20 cm on the both sides and 30 cm above the top panel of the unit. Otherwise it may not only damage the unit, but also cause fire.
6. Always set the VOLUME control to “– ∞” before starting the audio source play. Increase the volume gradually to an appropriate level after playback has been started.
7. Do not attempt to clean the unit with chemical solvents; this might damage the finish. Use a clean, dry cloth.
8. Be sure to read the “TROUBLESHOOTING” section regarding common operating errors before concluding that the unit is faulty.
9. When not planning to use this unit for long periods of time (ie., vacation, etc.), disconnect the AC power plug from the wall outlet.
10. To prevent lightning damage, disconnect the AC power plug and antenna cable when there is an electrical storm.
11. Grounding or polarization – Precautions should be taken so that the grounding or polarization of an appliance is not defeated.
12. Do not connect audio equipment to the AC outlet on the rear panel if the equipment requires more power than the outlet is rated to provide.
13. **Voltage Selector (China and General Models only)**
The voltage selector on the rear panel of this unit must be set for your local main voltage **BEFORE** plugging into the AC main supply.
Voltages are 110/120/220/240 V AC, 50/60 Hz.

FOR CANADIAN CUSTOMERS

TO PREVENT ELECTRIC SHOCK, MATCH WIDE BLADE OF PLUG TO WIDE SLOT AND FULLY INSERT.

THIS CLASS B DIGITAL APPARATUS MEETS ALL REQUIREMENTS OF THE CANADIAN INTERFERENCE-CAUSING EQUIPMENT REGULATIONS.

FREQUENCY STEP switch (China and General Models only)

Because the interstation frequency spacing differs in different areas, set the FREQUENCY STEP switch (located at the rear) according to the frequency spacing in your area. Before setting this switch, disconnect the AC power plug of this unit from the AC outlet.

WARNING

Do not change the IMPEDANCE SELECTOR switch setting while the power to this unit is on, otherwise this unit may be damaged.

IF THIS UNIT FAILS TO TURN ON WHEN THE STANDBY/ON SWITCH IS PRESSED;

The **IMPEDANCE SELECTOR** switch may not be set to either end. If so, set the switch to either end when this unit is in the standby mode.

IMPEDANCE SELECTOR

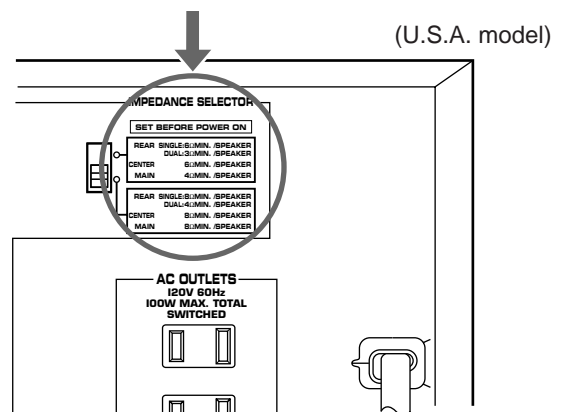

This unit is not disconnected from the AC power source as long as it is connected to the wall outlet, even if this unit itself is turned off. This state is called the standby mode. In this state, this unit is designed to consume a very small quantity of power.

NOTES ABOUT THE REMOTE CONTROL TRANSMITTER

Battery installation

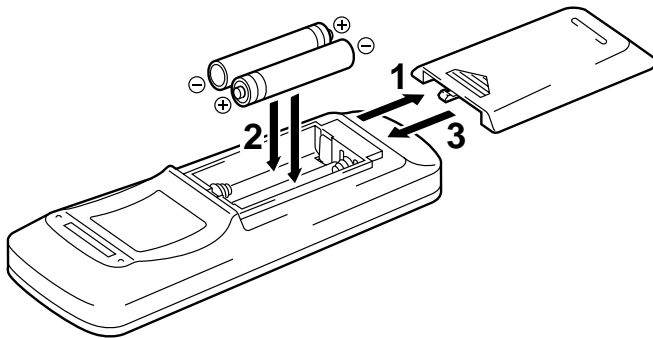

Battery replacement

If you find that the remote control transmitter must be used closer to the main unit, the batteries are weak. Replace both batteries with new ones.

Notes

- Use only AA, R6, UM-3 batteries for replacement.
- Be sure the polarities are correct. (See the illustration inside the battery compartment.)
- Remove the batteries if the remote control transmitter is not used for an extended period of time.
- If batteries leak, dispose of them immediately. Avoid touching the leaked material or letting it come in contact with clothing, etc. Clean the battery compartment thoroughly before installing new batteries.

Remote control transmitter operation range

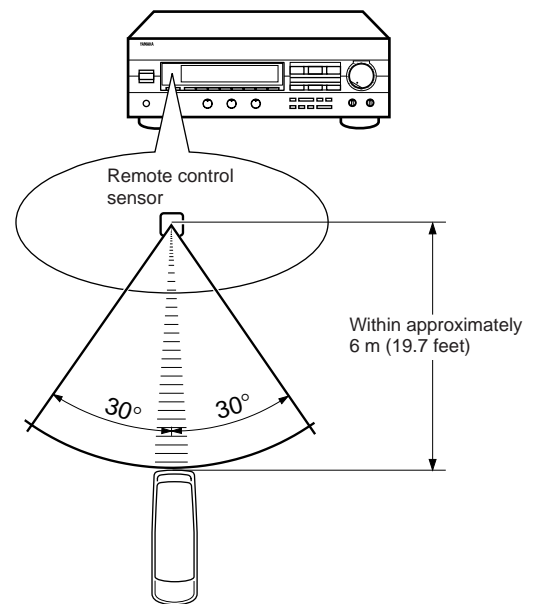

Notes

- There should be no large obstacles between the remote control transmitter and the main unit.
- If the remote control sensor is directly illuminated by strong lighting (especially an inverter type of fluorescent lamp etc.), it might cause the remote control transmitter not to work correctly. In this case, reposition the main unit to avoid direct lighting.

PROFILE OF THIS UNIT

You are the proud owner of a Yamaha stereo receiver –an extremely sophisticated audio component. The Digital Sound Field Processor (DSP) built into this unit takes advantage of Yamaha's undisputed leadership in the field of digital audio processing to bring you a whole new world of listening experiences. Follow the instructions in this manual carefully when setting up your system, and this unit will sonically transform your room into a totally new listening environment. In addition, you will get incredible realism from sources encoded with Dolby Surround using the built-in Dolby Pro Logic Surround Decoder. Please read this operation manual carefully and store it in a safe place for later reference.

Digital Sound Field Processing

What is it that makes live music so good? Today's advanced sound reproduction technology enables you to get extremely close to the sound of a live performance, but chances are you'll still notice something missing: the acoustic environment of the live concert hall. Extensive research into the exact nature of the sonic reflections that create the ambience of a large hall has made it possible for Yamaha engineers to bring you this same sound in your own listening room, so you'll feel all the sound of a live concert.

Furthermore, our technicians, armed with sophisticated measuring equipment, have even made it possible to capture the acoustics of actual music venues to allow you to accurately recreate live performance environments in your own home.

Dolby Pro Logic Surround

This unit employs a Dolby Pro Logic Surround decoder similar to professional Dolby Stereo decoders used in many movie theaters. By using the Dolby Pro Logic Surround decoder, you can experience the dramatic realism and impact of Dolby Stereo theater sound in your own home.

Dolby Pro Logic employs a four-channel-five-speaker system. The Pro Logic Surround system divides the input signal into four levels: the left and right main channels, the center channel (used for dialog), and the rear surround sound channel (used for sound effects, background noise, and other ambient noises). The center channel allows listeners seated in even less-than-ideal positions to hear the dialog originating from the action on the screen while experiencing good stereo imaging.

Dolby Surround is encoded on many sound tracks of pre-recorded video tapes, laserdiscs, and some TV/cable broadcasts. When you play a source encoded with Dolby Surround on this unit, the Dolby Pro Logic Surround decoder decodes the signal and supplies the surround-sound effects to you.

In addition, this unit features a built-in automatic input balance control. This always assures you of the best performance without manual adjustment.

Manufactured under license from Dolby Laboratories Licensing Corporation. "Dolby", the double-D symbol and "Pro Logic" are trademarks of Dolby Laboratories Licensing Corporation.

SPEAKER SETUP

SPEAKERS TO BE USED

This unit is designed to provide the best sound-field quality with a 5-speaker configuration. The most effective speakers to use with this unit are main speakers, rear speakers and a center speaker. You can use only one rear speaker instead of using two rear speakers, and omit the center speaker. (Refer to the “**SPEAKER CONFIGURATION**” shown below.)

The main speakers are used for the main source sound plus the effect sounds. They will probably be the speakers from your present stereo system. The rear speakers are used for the effect and surround sounds, and the center speaker is for the center sounds (dialog etc.) within the programs encoded with Dolby Surround. The center speaker needs to be equal in power to the main speakers although the rear speakers should not be equal. However, all the speakers should have high enough power handling to accept the maximum output of this unit.

SPEAKER CONFIGURATION

5-Speaker Configuration

This configuration is the most effective and recommended one. In this configuration, the center speaker is necessary as well as the rear speakers. If the program **PRO LOGIC** or **3 STEREO** is selected, conversations will be output from the center speaker and the ambience will be excellent.

- Set the center channel mode to the “**NORM**” or “**WIDE**” position. (For details, refer to page 16.)

4-Speaker Configuration (without the center speaker)

The center speaker is not used in this configuration. If the program **PRO LOGIC** is selected, the center sound will be output from the left and the right main speakers. The program **3 STEREO** has no effect in this configuration. However, the sound effect of other programs can be almost the same as that of the 5-speaker configuration.

- Be sure to set the center channel mode to the “**PHANTOM**” position. (For details, refer to page 16.)

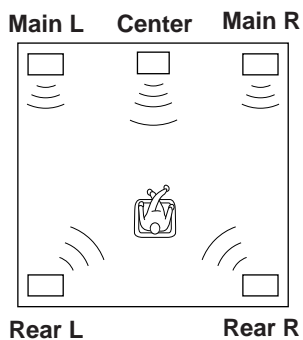

(Two rear speakers)

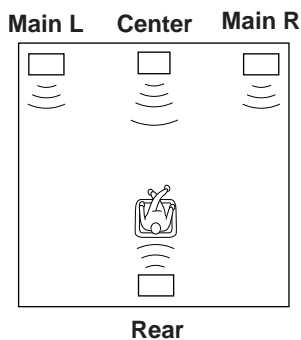

(One rear speaker)

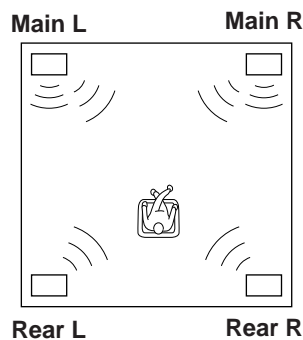

(Two rear speakers)

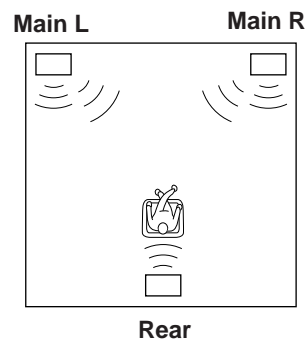

(One rear speaker)

Note

As this unit is equipped with a monaural amplifier for the rear channel, sounds output from the rear speakers are in monaural. So, you may use only one rear speaker instead of using two rear speakers. However, the use of two rear speakers is recommended when there is more than one listener in the listening room. When using one rear speaker, place it right behind your listening position.

SPEAKER PLACEMENT

The recommended speaker configuration, the 5-speaker configuration, will require two speaker pairs: **main speakers** (your normal stereo speakers), and **rear speakers**, plus a **center speaker**. When you place these speakers, refer to the following.

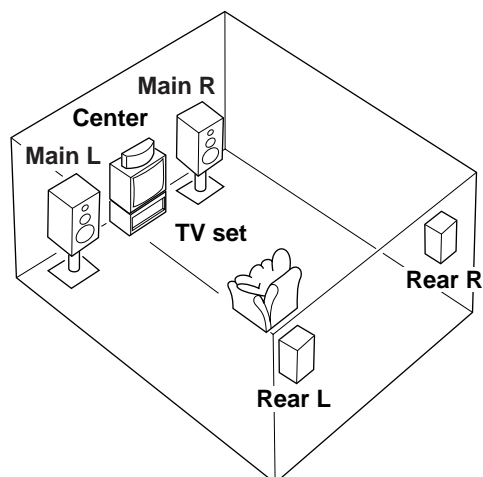

- Main:** In normal position. (The position of your present stereo speaker system.)
- Rear:** Behind your listening position, facing slightly inward. Nearly 1.8m (approx. 6 feet) up from the floor.
- Center:** Precisely between the main speakers. (To avoid interference with TV sets, use a magnetically shielded speaker.)

CONNECTIONS

Never plug in this unit and other components until all connections are completed.

CONNECTIONS WITH OTHER COMPONENTS

When making connections between this unit and other components, be sure all connections are made correctly, that is to say L (left) to L, R (right) to R, “+” to “+” and “-” to “-”. Also, refer to the owner’s manual for each component to be connected to this unit.

* If you have YAMAHA components numbered as 1, 3, 4, etc. on the rear panel, connections can be made easily by making sure to connect the output (or input) terminals of each component to the same-numbered terminals of this unit.

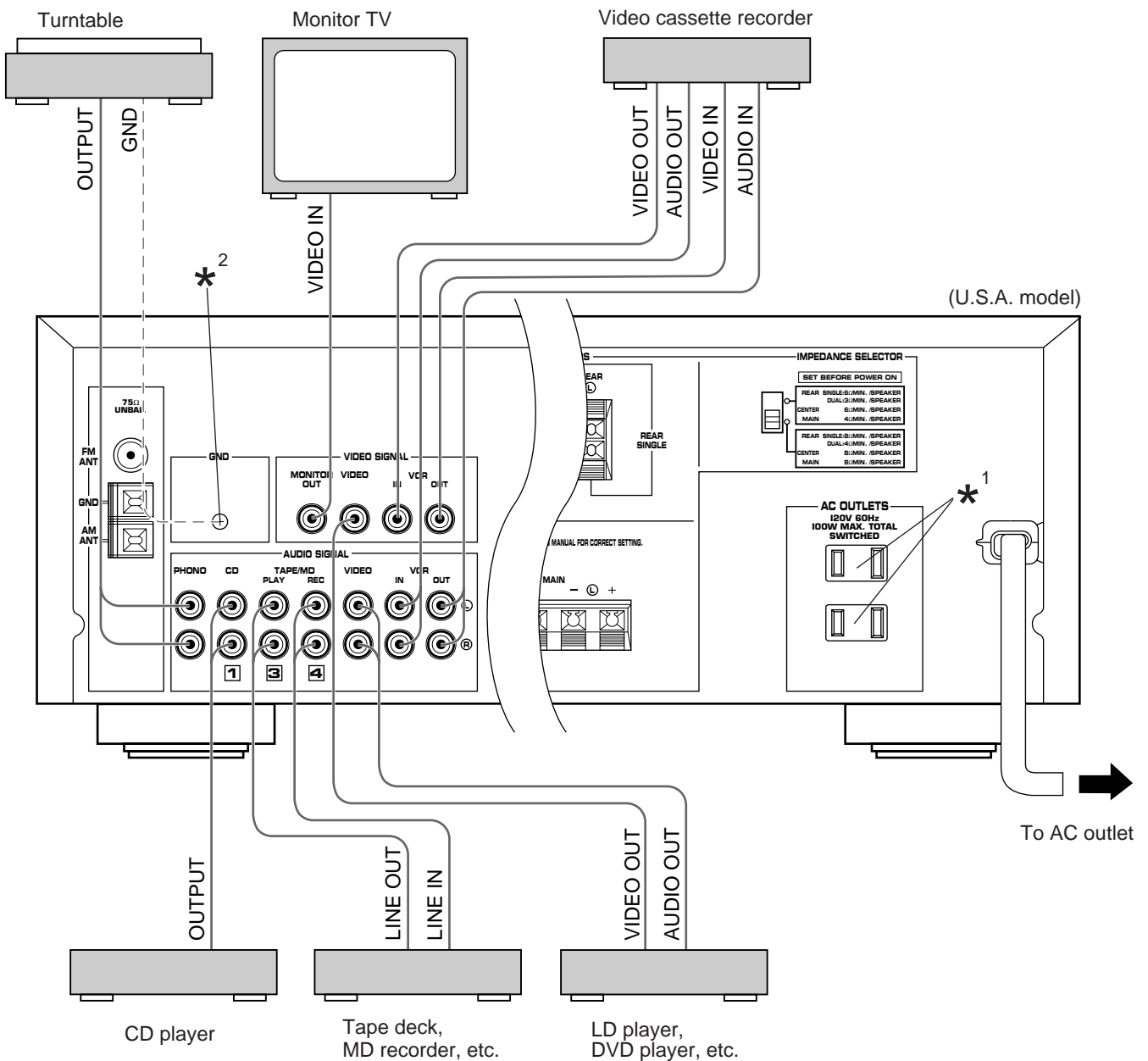

*¹, *²: See page 10.

CONNECTING SPEAKERS

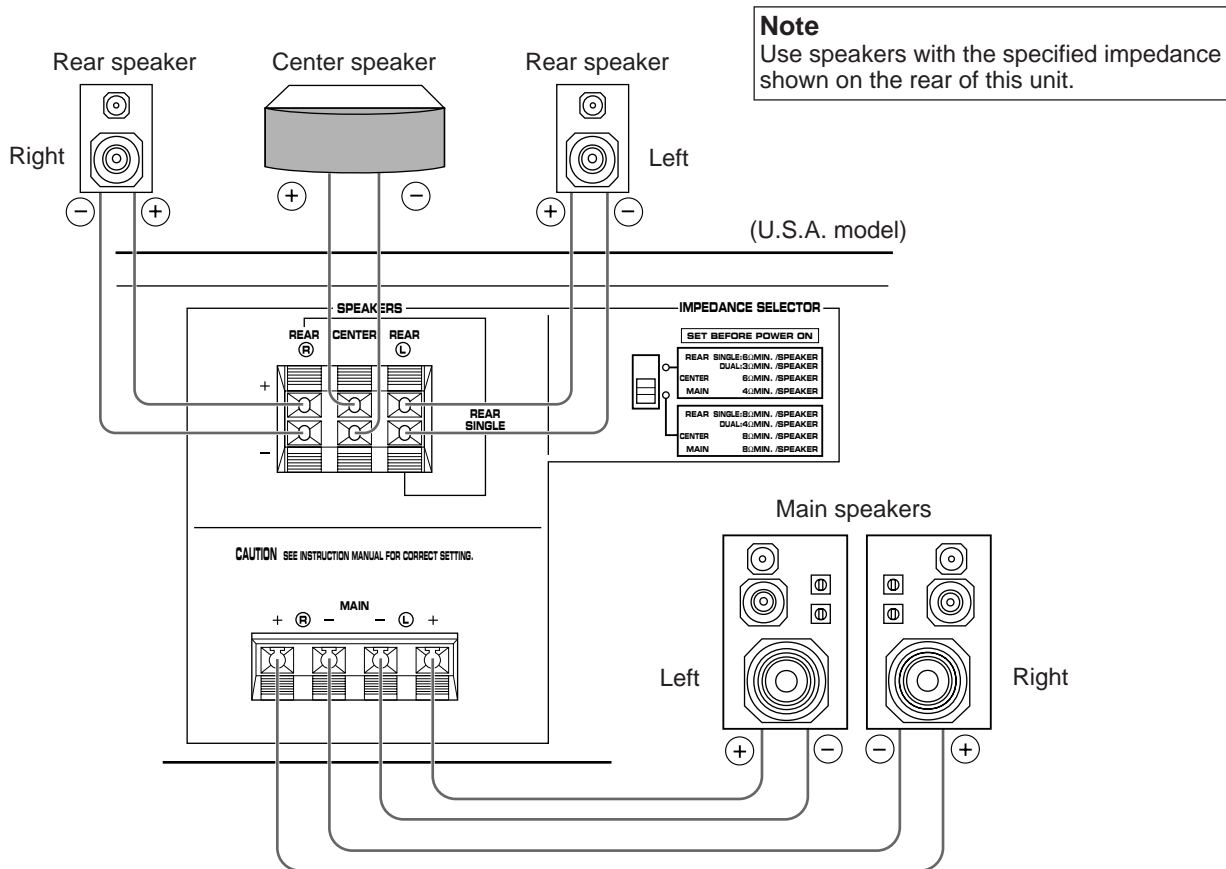

How to Connect:

Connect the **SPEAKERS** terminals to your speakers with wire of the proper gauge (cut as short as possible). If the connections are faulty, no sound will be heard from the speakers. Make sure that the polarity of the speaker wires is correct, that is the + and – markings are observed. If these wires are reversed, the sound will be unnatural and lack bass.

Caution

Do not let the bare speaker wires touch each other or any metal part of this unit. This could damage this unit and/or speakers.

For connecting to the MAIN SPEAKERS terminals

Red: positive (+)
Black: negative (–)

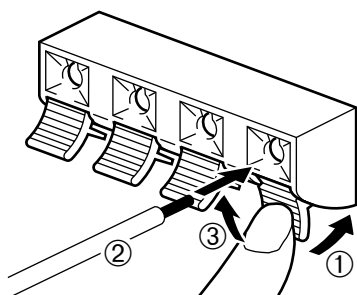

- 1 Press the tab.
- 2 Insert the bare wire.
[Remove approx. 5mm (1/4") insulation from the speaker wires.]
- 3 Release the tab and secure the wire.

For connecting to the REAR and CENTER SPEAKERS terminals

Red: positive (+)
Black: negative (–)

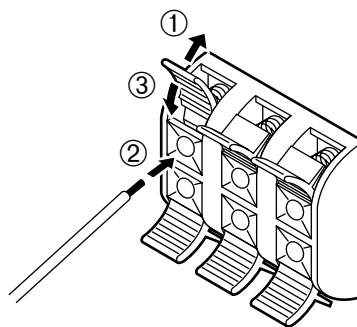

- 1 Press the tab.
- 2 Insert the bare wire.
[Remove approx. 5mm (1/4") insulation from the speaker wires.]
- 3 Release the tab and secure the wire.

Note on connecting only one rear speaker:

You can use only one rear speaker in place of two rear speakers. For connecting one rear speaker, follow the method shown on the right.

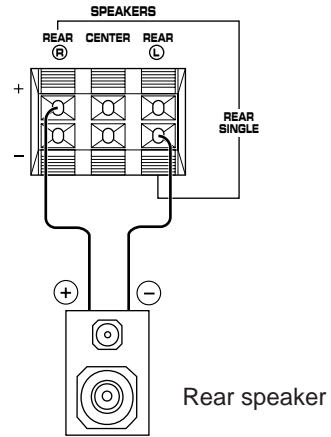

IMPEDANCE SELECTOR switch

Be sure to switch the position only when the power to this unit is not on. Select the position whose requirements your speaker system meets.

WARNING
 Do not change the **IMPEDANCE SELECTOR** switch setting while the power to this unit is on, otherwise this unit may be damaged.

IF THIS UNIT FAILS TO TURN ON WHEN THE STANDBY/ON SWITCH IS PRESSED;
 The **IMPEDANCE SELECTOR** switch may not be set to either end. If so, set the switch to either end when this unit is in the standby mode.

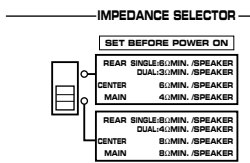

(U.S.A. model)

 (Upper position)

Rear: If you use one rear speaker, the impedance of the speaker must be 6Ω or higher. If you use two rear speakers, the impedance of each speaker must be 3Ω or higher.

Center: The impedance of the speaker must be 6Ω or higher.

Main: The impedance of each speaker must be 4Ω or higher.

 (Lower position)

Rear: If you use one rear speaker, the impedance of the speaker must be 8Ω or higher. If you use two rear speakers, the impedance of each speaker must be 4Ω or higher.

Center: The impedance of the speaker must be 8Ω or higher.

Main: The impedance of each speaker must be 8Ω or higher.

***¹ AC OUTLETS (SWITCHED)**

(U.S.A., Europe, Canada, China and General models) 2 SWITCHED OUTLETS
 (Australia model)..... 1 SWITCHED OUTLET

Use these to connect the power cords from your components to this unit. The power to the **SWITCHED** outlets is controlled by this unit's **STANDBY/ON** switch or the provided remote control transmitter's **POWER ϕ /I** key. These outlets will supply power to any component whenever this unit is turned on. The maximum power (total power consumption of components) that can be connected to the **SWITCHED AC OUTLETS** is 100 watts.

***² GND terminal (For turntable use)**

Connecting the ground wire of the turntable to the **GND** terminal will normally minimize hum, but in some cases better results may be obtained with the ground wire disconnected.

ANTENNA CONNECTIONS

- Each antenna should be connected to the designated terminal(s) correctly, referring to the following diagram.
- Both AM and FM indoor antennas are supplied to this unit. In general, these antennas will provide sufficient signal strength. Nevertheless, a properly installed outdoor antenna will give clearer reception than an indoor one. If you experience poor reception quality only with the indoor antennas, the use of an outdoor antenna may result in improvement.

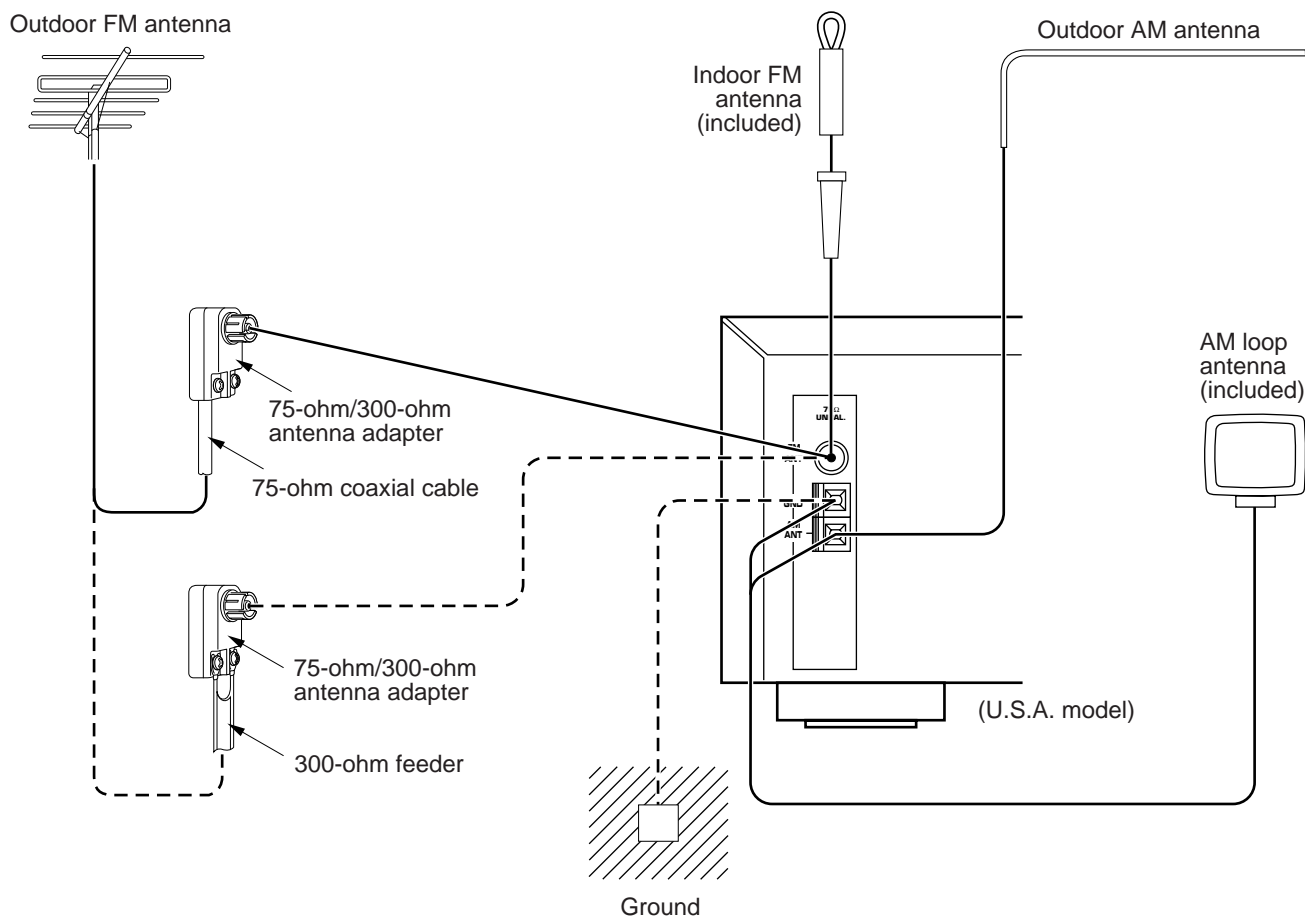

Connecting the AM loop antenna

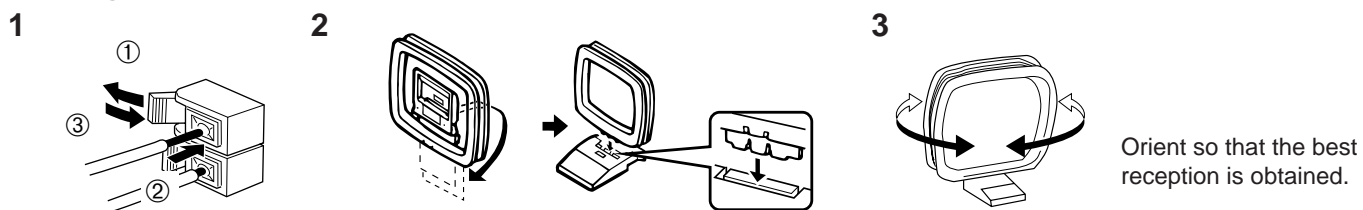

- * The AM loop antenna should be placed apart from the main unit. The antenna may be hung on a wall.
- * The AM loop antenna should be kept connected, even if an outdoor AM antenna is connected to this unit.

GND terminal

For maximum safety and minimum interference, connect the **GND** terminal to a good earth ground, which is a metal stake driven into moist earth.

Notes

- When connecting the indoor FM antenna, insert its connector into the **FM ANT** terminal firmly.
- If you need an outdoor FM antenna to improve FM reception quality, either 300-ohm feeder or coaxial cable may be used. In locations troubled by electrical interference, a coaxial cable is preferable.

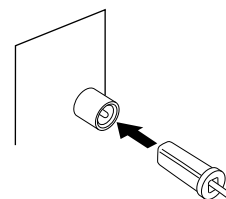

CONTROLS AND THEIR FUNCTIONS

FRONT PANEL

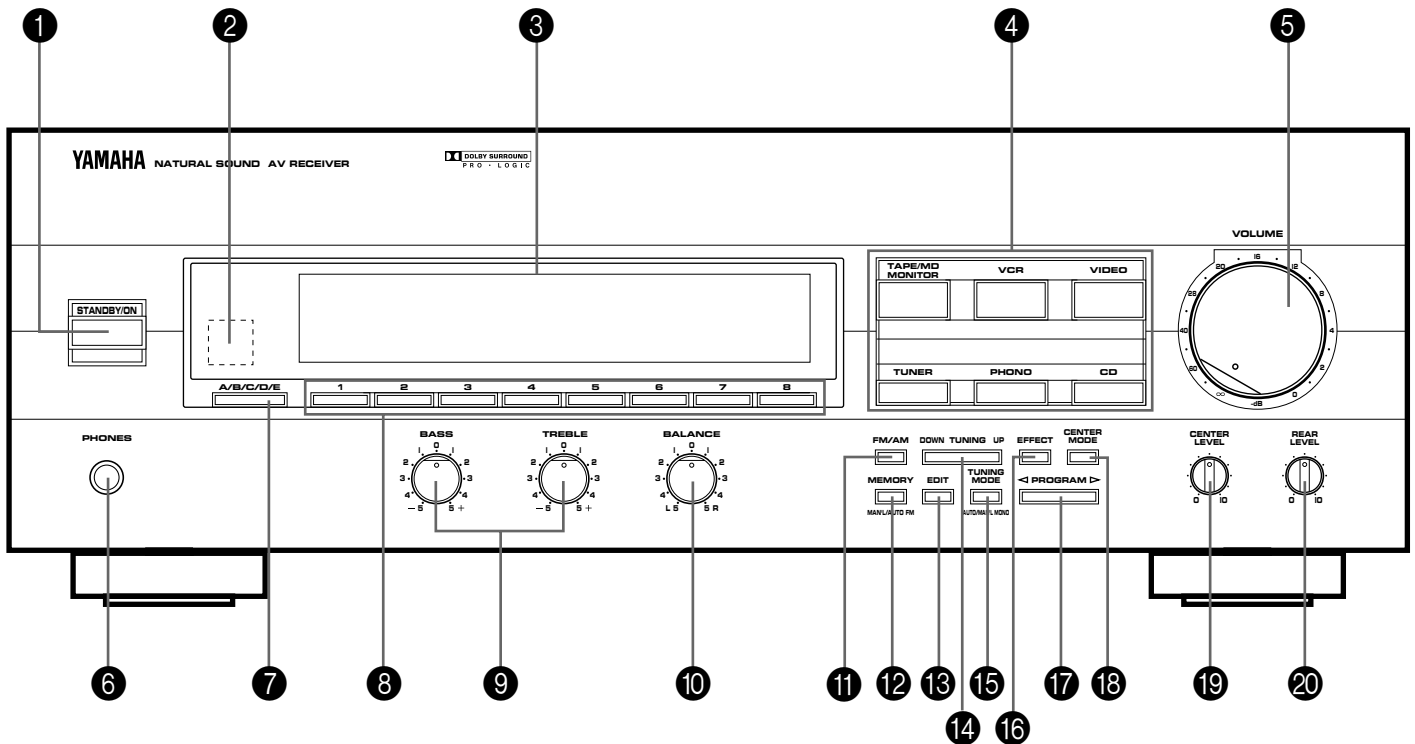

1 STANDBY/ON switch

Press this switch to turn on the power to this unit. Press it again to turn this unit into the standby mode.

Standby mode

In this state, this unit consumes a very small quantity of power to receive infrared-signals from the remote control transmitter.

2 Remote control sensor

Receives signals from the remote control transmitter.

3 Display panel

Shows various information. (For details, refer to page 15.)

4 Input selector buttons

Select a program source to listen to or watch. When a button is pressed, the name of the selected source appears on the display.

5 VOLUME control

Used to raise or lower the volume level.

6 PHONES jack

When you listen with headphones privately, connect the headphones to the **PHONES** jack and switch off the digital sound field processor (so that no DSP program name is illuminated on the display) by pressing the **EFFECT** button. You can listen to the sound to be output from the main speakers through headphones.

PHONES

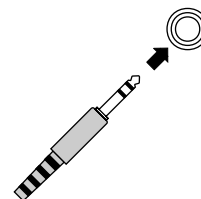

7 A/B/C/D/E button

Press this button to select a desired group (A–E) of preset stations.

8 Preset station number selector buttons

Select a preset station number (1 to 8).

9 Tone controls

These controls are effective only for the sound from the main speakers.

BASS

Used to increase or decrease the low frequency response. The 0 position produces flat response.

TREBLE

Used to increase or decrease the high frequency response. The 0 position produces flat response.

10 BALANCE control

This control is effective only for the sound from the main speakers.

Adjusts the balance of the output volume to the left and right speakers to compensate for sound imbalance caused by speaker location or listening room conditions.

11 FM/AM button

Press this button to switch the reception band to FM or AM.

12 MEMORY (MAN'L/AUTO FM) button

When this button is pressed, the "MEMORY" indicator flashes for about 5 seconds. While the indicator is flashing, select a desired preset station number by pressing the corresponding preset station number selector button to enter the displayed station into the memory.

When this button is held down for more than 3 seconds, the automatic preset tuning begins. (For details, refer to page 22.)

13 EDIT button

This button is used to exchange the places of two preset stations with each other.

14 TUNING DOWN/UP button

Used for tuning. Press the "UP" side to tune in to higher frequencies, and press the "DOWN" side to tune in to lower frequencies.

15 TUNING MODE (AUTO/MAN'L MONO) button

Press this button to switch the tuning mode to automatic or manual. To select the automatic tuning mode, press this button so that the "AUTO TUNING" indicator lights up on the display. To select the manual tuning mode, press this button so that the "AUTO TUNING" indicator goes off.

16 EFFECT button

Switches on/off the digital sound field processor (including the Dolby Pro Logic Surround decoder).

17 PROGRAM selector button

When the built-in digital sound field processor (including the Dolby Pro Logic Surround decoder) is on, this button changes the currently selected DSP program every time the right or left side of this button is pressed.

18 CENTER MODE button

Selects a center channel output mode (NORM, WIDE or PHANTOM). (For details, refer to page 16.)

19 CENTER LEVEL control

Adjusts the sound output level of the center speaker.

20 REAR LEVEL control

Adjusts the sound output level of the rear speakers.

REMOTE CONTROL TRANSMITTER

The remote control transmitter supplied to this unit is designed to control all the most commonly used functions of this unit. If the CD player and tape deck connected to this unit are YAMAHA components designed for remote control compatibility, this remote control transmitter will also control various functions of each component.

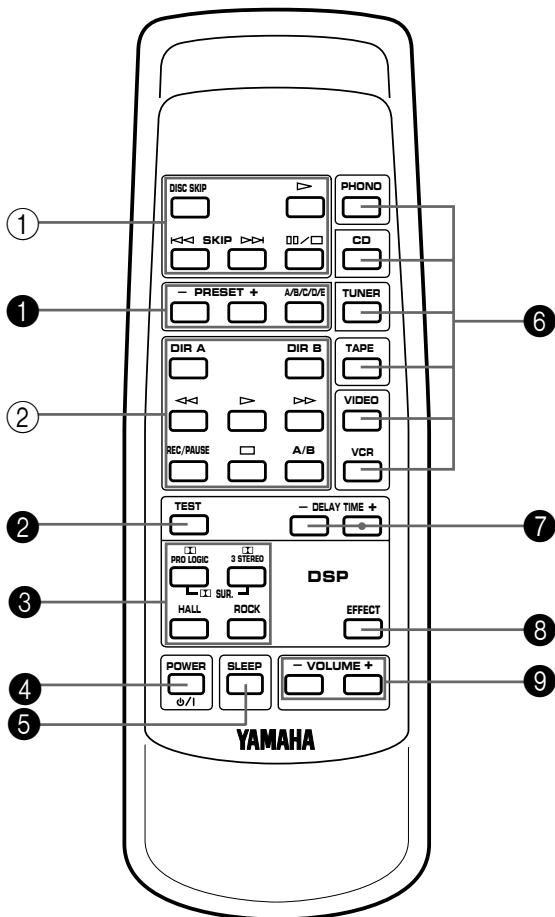

③ DSP program selector keys

Select a DSP program. When a key is pressed, the name of selected program lights up on the display.

④ POWER ϕ/I key

Turns the power to this unit on and turns this unit into the standby mode alternately.

⑤ SLEEP timer key

This unit is automatically turned into the standby mode one hour after this key is pressed (so that "SLEEP" indicator lights up). To cancel this function, press this key again so that "SLEEP" indicator goes off.

⑥ Input selector keys

Select input source.

⑦ DELAY TIME +/- keys

Adjust the delay time, or the time difference between the beginning of source sound and the beginning of effect sound. (For details, refer to page 26.)

⑧ EFFECT key

Switches on/off the digital sound field processor (including the Dolby Pro Logic Surround decoder).

⑨ VOLUME +/- keys

Turn the volume level up/down.

For Control of This Unit

① Tuner keys

Control tuner.

+: Selects higher preset station number.

-: Selects lower preset station number.

A/B/C/D/E: Selects the group (A – E) of preset station numbers.

② TEST key

Used for speaker balance adjustment. (For details, refer to page 16–17.)

For Other Component Control

Identify the remote control transmitter keys with your component's keys. If these keys are identical, their functions will be the same. On each key function, refer to the corresponding instruction on your component's manual.

① CD player keys

Control compact disc player.

* **DISC SKIP** is applicable only to compact disc changer.

② Tape deck keys

Control tape deck.

* **DIR A**, **DIR B** and **A/B** are applicable only to double cassette tape deck.

* For a single cassette deck with automatic reverse function, pressing **DIR A** will reverse the direction of tape running.

DISPLAY PANEL

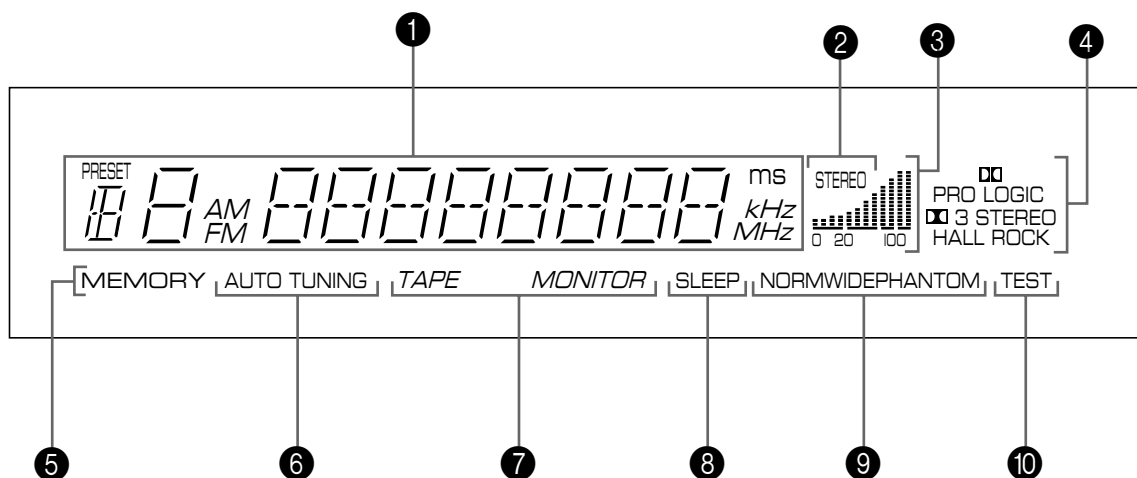

1 Multi-information display

Displays various information, for example station frequency, preset station number and name of selected input source.

2 STEREO indicator

Lights up when an FM stereo broadcast with sufficient signal strength is received.

3 Signal-level meter

Indicates the signal level of the received station. If multipath interference is detected, the indication decreases.

4 DSP program indicators

The name of a selected DSP program lights up only when a program which uses the Dolby Pro Logic Surround decoder is on.

5 MEMORY indicator

When the **MEMORY** button is pressed, this indicator flashes for about 5 seconds. While this indicator is flashing, the displayed station can be programmed to the memory by using the **A/B/C/D/E** button and the preset station number selector buttons.

6 AUTO TUNING indicator

Lights up when this unit is in the automatic tuning mode.

7 TAPE MONITOR indicator

Lights up when the tape deck (or MD recorder etc.) is selected as the input source by pressing the **TAPE/MD MONITOR** button.

8 SLEEP indicator

Lights up while the built-in SLEEP timer is functioning.

9 Center channel mode indicators

The name of a selected center channel mode lights up only when a program which uses the Dolby Pro Logic Surround decoder is selected.

10 TEST indicator

Flashes when the built-in test tone generator is functioning (when the test-tone is output from speakers).

SPEAKER BALANCE ADJUSTMENT

This procedure lets you adjust the sound output level balance between the main, center, and rear speakers using the built-in test tone generator. When this adjustment is made, the sound output level heard at the listening position will be the same from each speaker. This is important for the best performance of the digital sound field processor and the Dolby Pro Logic Surround decoder.

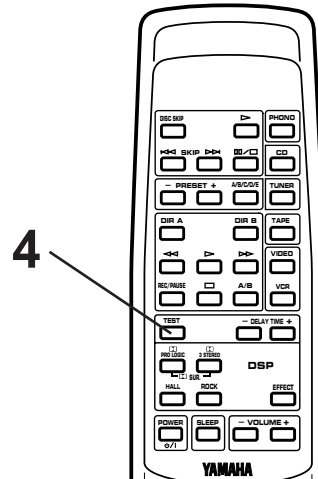
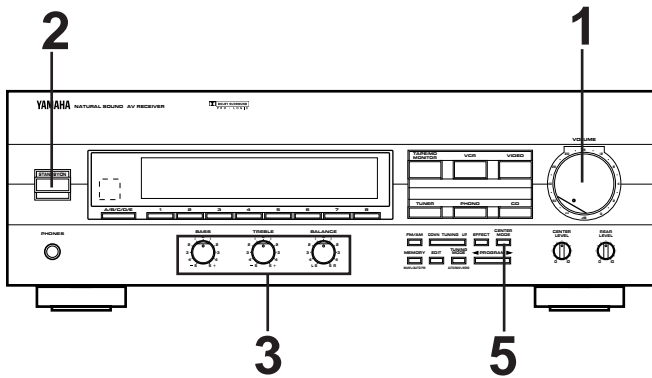

1

Set to the "∞" position.

2 Turn the power on.

3

Set to the "0" position.

4

5 Select the center channel output mode suitable for your speaker configuration. (Refer to "SPEAKER CONFIGURATION" on page 7.)

On the feature of each mode, refer to the "Note" shown below.

- Note**
In step 5, when you select a center channel output mode, note the following.
- For 5-speaker configuration)**
- NORM:** Select this mode when you use a center speaker that is smaller than the main speakers. In this mode, the bass tone will be output from the main speakers.
 - WIDE:** Select this mode when you use the center speaker approximately same sized as the main speakers.
- For 4-speaker configuration)**
- PHANTOM:** Select this mode when you do not use the center speaker. The center sound will be output from the left and right main speakers.

CONTINUED

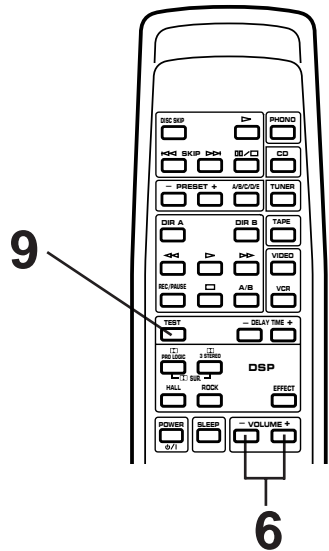
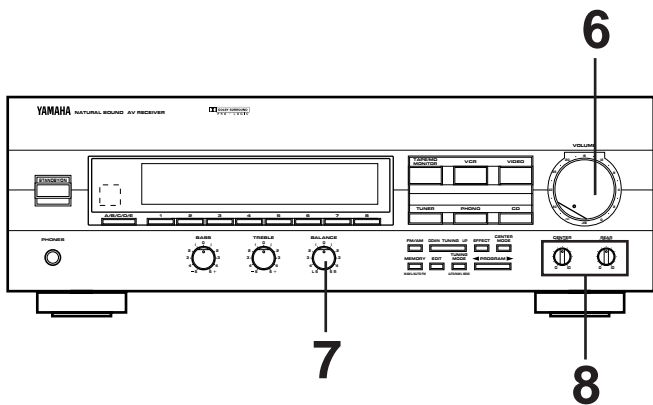

6 Turn up the volume.

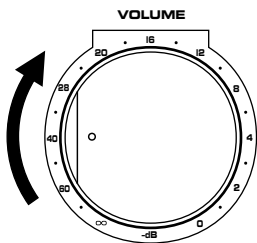

You will hear a test tone (like pink noise) from the left main speaker, then the center speaker, then the right main speaker, and then the rear speakers, for about two seconds each. The display changes as shown below.

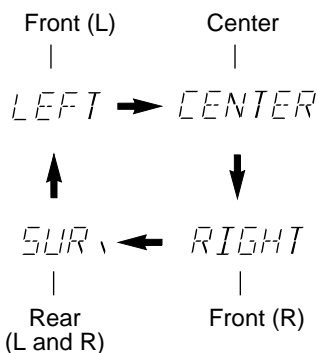

* The test tone from the left rear speaker and the right rear speaker will be heard at the same time.

7 Adjust the **BALANCE** control so that the effect sound output level of the left main speaker and the right main speaker are the same.

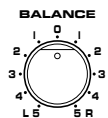

8 Adjust the sound output levels of the center speaker and the rear speakers so that they become almost as same as those of the main speakers.

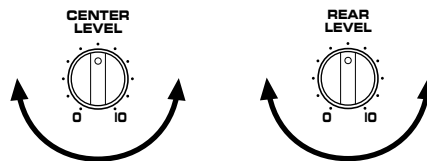

9 Cancel the test tone.

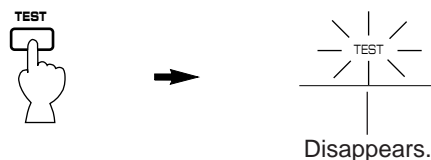

Notes

- Once you have completed these adjustments, you can adjust whole sound level on your audio system by using the **VOLUME** control (or the **VOLUME** keys on the remote control transmitter) only.
- If you use external power amplifiers, you may also use their volume controls to obtain proper balance.
- In step 5, if the center channel mode is in the "PHANTOM" position, the sound output level of the center speaker cannot be adjusted. This is because in this mode, the center sound is automatically output from the left and right main speakers.

From page 18 to 26, this manual describes how to operate this unit mainly by using the front panel control parts. To operate this unit on the remote control transmitter, use the corresponding keys on the remote control transmitter.

BASIC OPERATIONS

TO PLAY A SOURCE

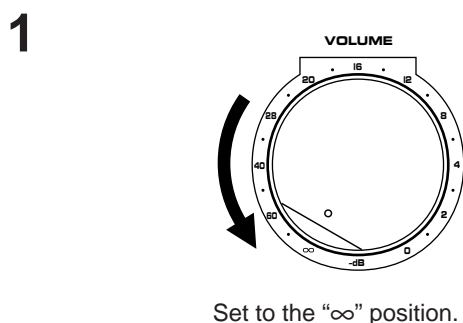
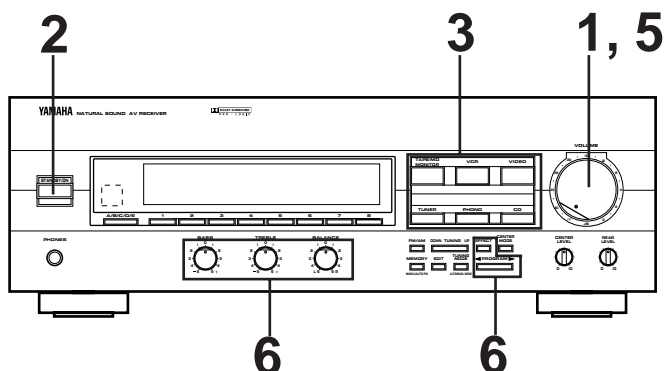

2 Turn the power on.

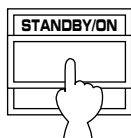

3 Select the desired input source by using the input selector buttons.
(For video sources, turn the TV/monitor ON.)

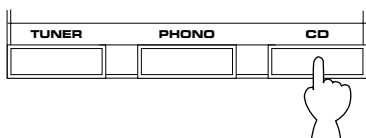

* The name of the selected input source will appear on the display.

4 Play the source. (For detailed information on the tuning operation, refer to page 20.)

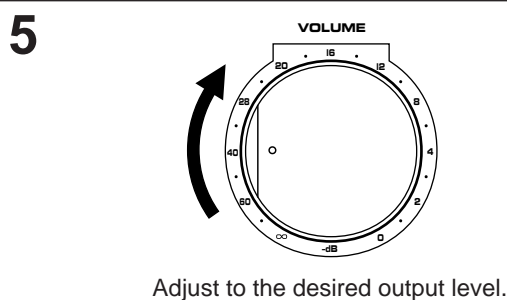

6 If desired, adjust the **BASS**, **TREBLE** and **BALANCE** controls (refer to page 19), and use the digital sound field processor. (Refer to page 25.)

Notes on using the input selector buttons

- Note that pressing each input selector button selects the source which is connected to the corresponding input terminals on the rear panel.
- The selection of **TAPE/MD MONITOR** cannot be canceled by pressing another input selector button. To cancel it, press **TAPE/MD MONITOR** again so that the "TAPE MONITOR" indicator disappears from the display. When you select a button other than **TAPE/MD MONITOR**, make sure that the "TAPE MONITOR" indicator is not illuminated on the display.
- If you select the input selector button for a video source without canceling the selection of **TAPE/MD MONITOR**, the playback result will be the video image from the video source and the sound from the audio tape (or MD etc.).
- Once you play a video source, its video image will not be interrupted even if the input selector button for an audio source is selected.

When you finish using this unit

Press the **STANDBY/ON** switch on the front panel again or the **POWER** key on the remote control transmitter to turn this unit into the standby mode.

TO RECORD A SOURCE TO TAPE (OR MD)

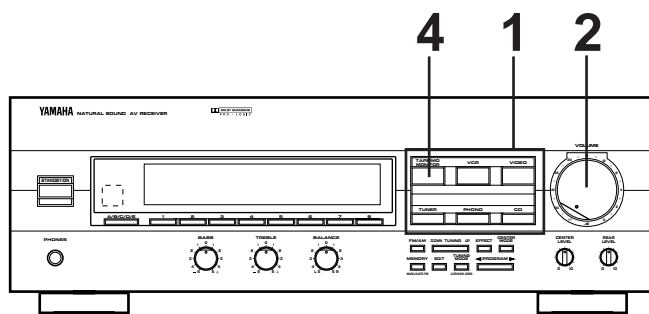

1 Select the source to be recorded.

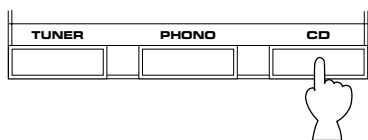

2 Play the source and then turn the **VOLUME** control up to confirm the input source. (For detailed information on the tuning operations, refer to the page 20.)

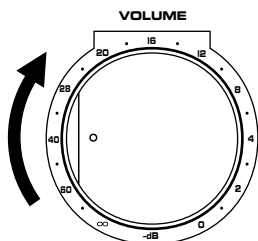

3 Begin recording on the tape deck (or MD recorder etc.) or VCR connected to this unit.

4 If the tape deck (or MD recorder etc.) is used for recording, you can monitor the sounds being recorded by pressing **TAPE/MD MONITOR** so that the "TAPE MONITOR" indicator lights up on the display.

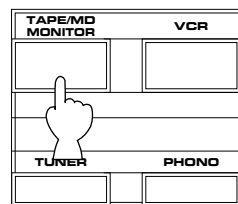

Note

The settings of DSP and the **VOLUME, BASS, TREBLE** and **BALANCE** controls have no effect on the material being recorded.

Adjusting the **BALANCE** control

Adjust the balance of the output volume to the left and right speakers to compensate for sound imbalance caused by speaker location or listening room conditions.



Note

This control is effective only for the sound from the main speakers.

Adjusting the **BASS** and **TREBLE** controls

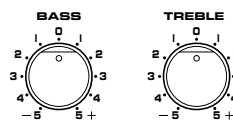

BASS : Turn this clockwise to increase (or counter-clockwise to decrease) the low frequency response.

TREBLE : Turn this clockwise to increase (or counter-clockwise to decrease) the high frequency response.

Note

These controls are effective only for the sound from the main speakers.

TUNING OPERATIONS

Normally, if station signals are strong and there is no interference, quick automatic-search tuning (AUTOMATIC TUNING) is possible. However, if signals of the station you want to select are weak, you must tune to it manually (MANUAL TUNING).

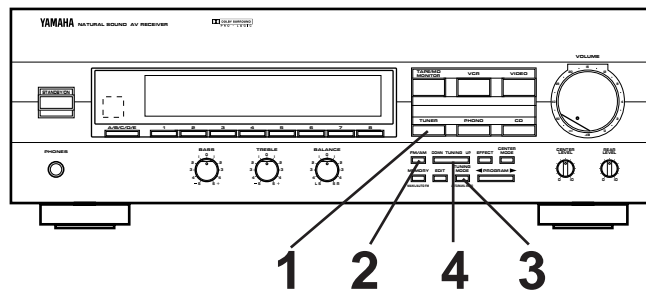

AUTOMATIC TUNING

- 1** Select "TUNER" as the input source.

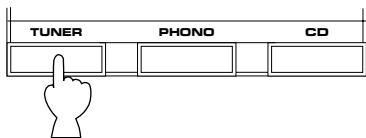

- 2** Select the reception band (FM or AM) confirming it on the display.



- 3** Turn the "AUTO TUNING" indicator off.

- 4** To tune to a higher frequency, press the right side once.
To tune to a lower frequency, press the left side once.

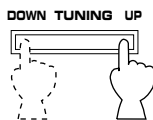

- * If the station where tuning search stops is not the desired one, press the button again.
- * If the tuning search does not stop at the desired station (because the signals of the station are weak), change it to the MANUAL TUNING method.

MANUAL TUNING

- 1** Select "TUNER" as the input source.

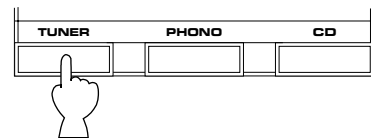

- 2** Select the reception band (FM or AM) confirming it on the display.



- 3** Turn the "AUTO TUNING" indicator off.

- 4** Tune to a desired station manually.

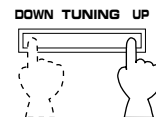

- * To continue tuning search, hold down the button.

Note

If you tune to an FM station manually, it is received in monaural mode automatically to increase the signal quality.

PRESET TUNING

MANUAL PRESET TUNING

This unit can store station frequencies selected by tuning operation. With this function, you can recall any desired station only by selecting the preset station number where it is stored. Up to 40 stations (8 stations x 5 groups) can be stored.

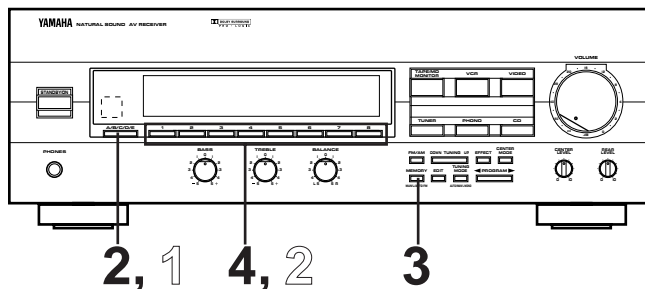

To store stations

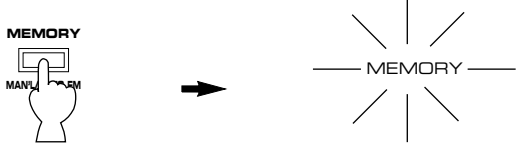
- 1 Tune to a desired station.
(Refer to the previous page for tuning procedure.)
- 2 Select a desired group (A – E) of preset stations confirming it on the display.
 
- 3
 

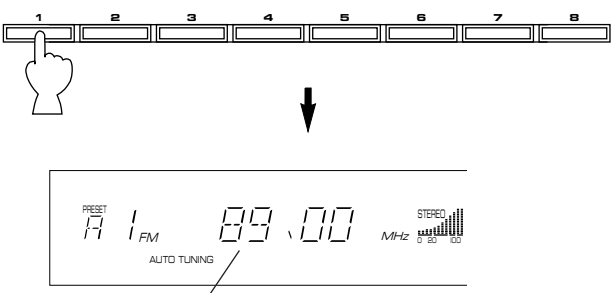
Flashes on and off for about 5 seconds.
- 4 Select a preset station number where you want to program the station before the “MEMORY” indicator goes off from the display.
 

Shows the displayed station has been programmed to A1.

* In the same way, program other stations to A2, A3 ... A8.
* You can program more stations to preset station numbers of other groups in the same way by selecting other groups in step 2.

To recall a preset station

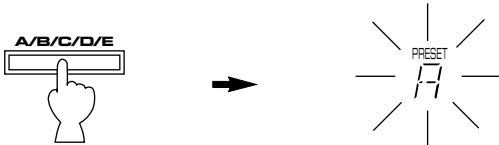
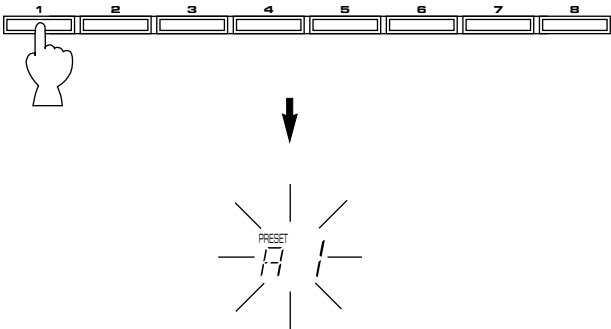
- 1 Select the group of preset stations.
 
- 2 Select the preset station number.
 

Notes

- A new setting can be programmed in place of the former one.
- For presets, the setting of the reception mode (stereo or monaural) is stored along with the station frequency.

Memory back-up

The memory back-up circuit prevents the programmed data from being lost even if this unit is turned into the standby mode or the power plug is disconnected from the AC outlet or the power is cut due to temporary power failure. If, however, the power is cut for more than one week, the memory may be erased. If so, it can be re-programmed by simply following the PRESET TUNING steps.

AUTOMATIC PRESET TUNING

You can make use of an automatic preset tuning function for FM stations. With this function, this unit performs automatic tuning and stores FM stations with strong signals sequentially. Up to 40 stations are stored automatically in the same way as in the manual preset tuning method on page 21.

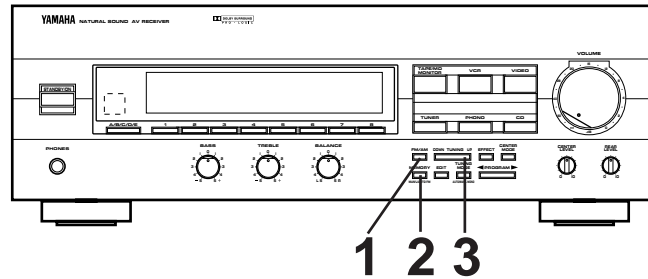

To store stations

| | |
|----------|--|
| 1 | |
| 2 | <p style="text-align: center;">Flashes.</p> |
| 3 | <p>To tune to higher frequencies, press right side once. To tune to lower frequencies, press left side once. * If the TUNING button is not pressed, in a while, the automatic preset tuning begins automatically toward higher frequencies.</p> <p>The automatic preset tuning begins from the frequency currently displayed. Received stations are programmed to A1, A2 ... A8 sequentially. * If more than 8 stations are received, they are also programmed to the preset station numbers of other groups (B, C, D and E) in that order.</p> |

When the automatic preset tuning is finished;

The display shows the frequency of the last preset station. Check the contents and the number of preset stations by following the procedure of the section "To recall a preset station" on page 21.

To recall a preset station

Simply follow the procedure of the section "To recall a preset station" on page 21.

Notes

- You can replace a preset station by another FM or AM station manually by simply following the procedure of the section "To store stations" on page 21.
- If the number of received stations is not enough to be stored up to E8, the search will be finished automatically after searching all frequencies.
- With this function, only FM stations with sufficient signal strength are stored automatically. If the station you want to program is weak in signal strength, tune to it in monaural manually and program it by following the procedure of the section "To store stations" on page 21.

If you want to store the first station received by the automatic preset tuning to a desired preset station number;

If, for example, you want to store the first received station to C5, select "C5" by using the **A/B/C/D/E** button and the preset station number selector buttons after pressing the **MEMORY** button in step 2. Then press the **TUNING** button. The first received station is stored to C5, and next stations to C6, C7 ... sequentially.

If stations are stored up to E8, the automatic preset tuning will be finished automatically.

EXCHANGING PRESET STATIONS

You can exchange the places of two preset stations with each other as shown below.

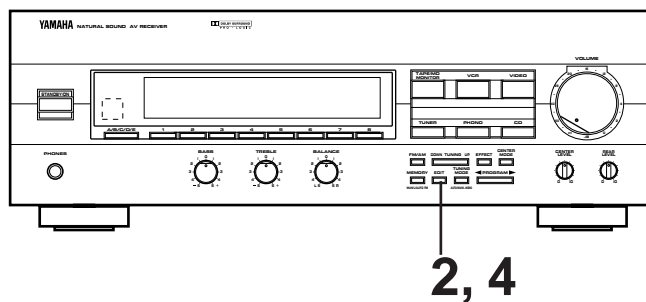

Example)

If you want to shift the preset station on E1 to A5, and vice versa.

1 Recall the preset station on E1 (by following the method of "To recall a preset station" on page 21).

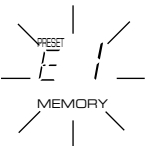
2  → 
Flashes.

3 Recall the preset station on A5 by following the same method as in step 1.

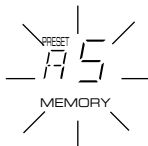
Flashes.

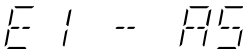
4  → 
Shows the exchange of stations is completed.

USING DIGITAL SOUND FIELD PROCESSOR (DSP)

This unit incorporates a sophisticated digital sound field processor. The processor allows you to electronically expand and change the shape of the audio sound field from both audio and video sources, creating a theater-like experience in your listening room. In addition, this unit incorporates a Dolby Pro Logic Surround decoder for multi-channel sound reproduction of sources encoded with Dolby Surround. The operation of the Dolby Pro Logic Surround decoder can be controlled by selecting a corresponding DSP program.

You can create an excellent audio sound field by selecting a suitable sound field program (this will, of course, depend on what you will be listening to), and adding desired adjustments.

Brief Overview of Digital Sound Field Programs

The following list gives you a brief description of the sound fields produced by each of the DSP programs. Keep in mind that most of these are precise digital recreations of actual acoustic environments. The data for these sound fields was recorded at actual locations using sophisticated sound field measurement equipment.

Note
The channel level balance between the left and right rear effect speakers may vary depending on the sound field you are listening in. This is due to the fact that most of these sound field recreations are actual acoustic environments.

| PROGRAM | FEATURE |
|---|---|
| <input checked="" type="checkbox"/> PRO LOGIC | This program is used for playback of sources encoded with Dolby Surround. Dialog is oriented on the screen and effect sounds are effectively located on the left front, right front and rear surround sides respectively as the movie sound creator designed. |
| <input checked="" type="checkbox"/> 3 STEREO | This program is effective not only for playback of sources encoded with Dolby Surround, but also for sources not encoded with Dolby Surround or TV programs encoded with 2-channel stereo sound. With this program, 2-channel stereo sound is converted into 3-channels (left front, center and right front), so dialog is emphasized on the center position by the use of the center speaker. As no sound is output from the rear speakers, this program is also effective in a simple Audio/Video system without rear speakers. |
| HALL | In this program, the center will appear to be deep behind the main speakers, creating an expansive large hall ambience. Orchestra and opera music are suited for this sound field. |
| ROCK | This program is ideally suited for rock music. You will experience a very dynamic or lively sound field. |

Playing a source with an effect of the digital sound field processor (DSP)

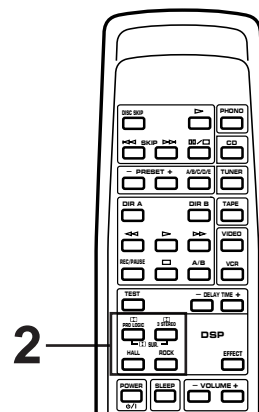
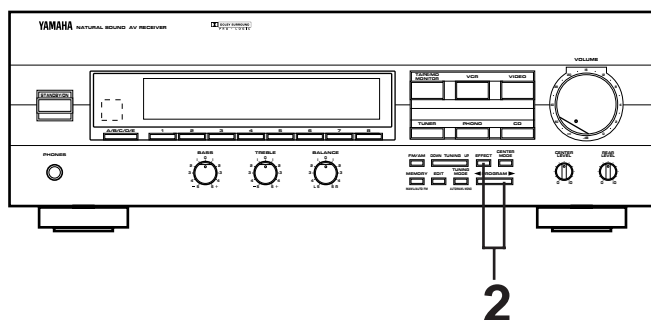

1 Follow steps 1 – 5 shown in “**BASIC OPERATIONS**” on page 18.

2 Select the desired program that is suitable for the source.

On the remote control transmitter:

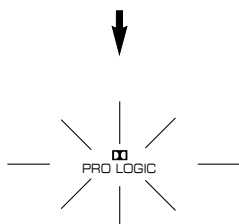
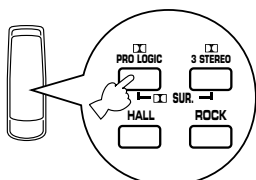

On the front panel:



Turn on the DSP so that a program name lights up on the display.

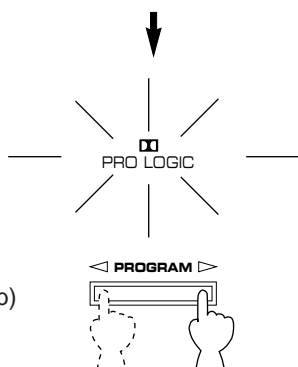

Select a desired program confirming it on the display.

The selected program name is shown on the display.

3 If desired, adjust the delay time and the output level of each speaker. (For details, refer to the corresponding descriptions on page 26.)

Notes

- Program selection can be made to individual input sources. Once you select a program, it is linked with the input source selected at that time. So, when you select the input source the next time, the same program will be automatically called.
- If you prefer to cancel the DSP, press the **EFFECT** button. The sound will be the normal 2-channel stereo without surround sound effect.
- When **HALL** or **ROCK** is selected, no sound is heard from the center speaker.
- When a monaural sound source is played with **PRO LOGIC**, no sound is heard from the rear speakers.
- When **PRO LOGIC** is selected, if the main-source sound is considerably altered by overadjustment of the **BASS** or **TREBLE** control, the relationship between the center and rear channels may produce an unnatural effect.

Adjustment of the CENTER LEVEL

If desired, you can adjust the sound output level of the center speaker even if the output level is already set in "SPEAKER BALANCE ADJUSTMENT" on page 17.

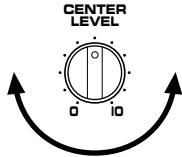

Note

This adjustment is useful only when the digital sound field program **PRO LOGIC** or **3 STEREO** is selected.

Adjustment of DELAY TIME

You can adjust the time difference between the beginning of the sound from the main speakers and the beginning of the effect sound from the rear speakers.

The larger the value, the later the effect sound is generated. This adjustment can be made to all programs (except **3 STEREO**) individually.

Control range: 15, 20, 25, 30 milliseconds

Preset value

| | |
|-------------------|-----------------|
| PRO LOGIC: | 25 milliseconds |
| HALL: | 20 milliseconds |
| ROCK: | 15 milliseconds |

This adjustment can be made only by using the remote control transmitter.

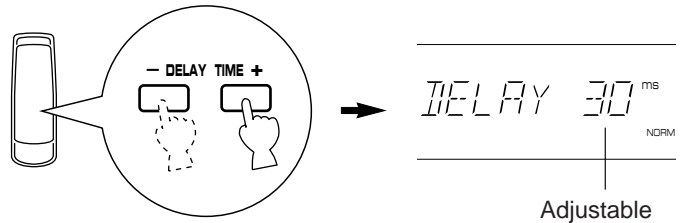

Notes

- When **3 STEREO** is selected, this adjustment cannot be made.
- Adding too much delay will cause an unnatural effect with some sources.
- The value of the delay time you last set will remain memorized even when this unit is in the standby mode. However, if the power cord is kept disconnected for more than one week, these values will be automatically changed back to the original factory settings.
- When the **DELAY TIME** key is pressed, the sound may be momentarily interrupted.

Adjustment of the REAR LEVEL

If desired, you can adjust the sound output level of the rear speakers even if the output level is already set in "SPEAKER BALANCE ADJUSTMENT" on page 17.

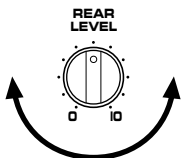

Note

This adjustment is useful only when the digital sound field program **PRO LOGIC**, **ROCK** or **HALL** is selected.

TROUBLESHOOTING

If the unit fails to operate normally, check the following points to determine whether the fault can be corrected by the simple measures suggested. If it cannot be corrected, or if the fault is not listed in the SYMPTOM column, disconnect the power cord and contact your authorized YAMAHA dealer or service center for help.

| | SYMPTOM | CAUSE | REMEDY |
|-------------------------------|--|--|---|
| Amplifier | The unit fails to turn on when the STANDBY/ON switch is pressed, or turns into the standby mode suddenly soon after the power is turned on. | Power cord is not plugged in or is not completely inserted. | Firmly plug in the power cord. |
| | | The IMPEDANCE SELECTOR switch on the rear panel is not set to either end. | Set the switch to either end when this unit is in the standby mode. |
| | It happens that this unit does not work normally. | There is an influence of strong external noise (lightning, excessive static electricity, etc.) or a misoperation on this unit while using this unit. | Turn this unit into the standby mode and disconnect the AC power cord from the AC outlet. After about 30 seconds pass, connect the power and operate this unit again. |
| | No sound or no picture. | Incorrect output cord connections. | Connect the cords properly. If the problem persists, the cords may be defective. |
| | | Appropriate input source is not selected. | Select an appropriate input source with the input selector buttons. |
| | | Speaker connections are not secure. | Secure the connections. |
| | The sound suddenly goes off. | The protection circuit has been activated because of short circuit etc. | Turn this unit into the standby mode, and then turn on to reset the protection circuit. |
| | | The SLEEP timer has functioned. | Cancel the SLEEP timer function. |
| | Only one side speaker outputs the sound. | Incorrect setting of the BALANCE control. | Adjust it to the appropriate position. |
| | | Incorrect cord connections. | Connect the cords properly. If the problem persists, the cords may be defective. |
| | Sound "hums". | Incorrect cord connections. | Firmly connect the audio plugs. If the problem persists, the cords may be defective. |
| | | No connection from the turntable to the GND terminal. | Make the GND connection between the turntable and this unit. |
| | The volume level is low while playing a record. | The record is being played on a turntable with an MC cartridge. | The player should be connected to the unit through the MC head amplifier. |
| | The volume level cannot be increased, or sound is distorted. | The component connected to the REC terminals of this unit is turned off. | Turn the power to the component on. |
| | No sound from the rear speakers. | The sound output level to the rear speakers is set to minimum. | Raise the sound output level to the rear speakers. |
| | | The monaural sound source is played when  PRO LOGIC is selected. | Select another program suitable for the monaural sound source. |
| | No sound from the center speaker. | The sound output level to the center speaker is set to minimum. | Raise the sound output level to the center speaker. |
| | | The center channel mode is in PHANTOM mode. | Select NORM or WIDE. |
| | | Incorrect sound field program selection. | Select the appropriate program. |
| FM stereo reception is noisy. | Because of the characteristics of FM stereo broadcasts, this is limited to cases where the transmitter is too far away or the antenna input is poor. | Check the antenna connections. Try using a high quality directional FM antenna. Set the TUNING MODE button to the manual tuning mode. | |
| FM | There is distortion and clear reception cannot be obtained even with a good FM antenna. | There is multipath interference. | Adjust antenna placement to eliminate multipath interference. |
| | A desired station cannot be tuned in with the automatic tuning method. | The station is too weak. | Use the manual tuning method. Use a high quality directional FM antenna. |
| | Previously preset stations can no longer be tuned in. | This unit has been unplugged for a long period. | Repeat the presetting procedure. |
| AM | A desired station cannot be tuned in with the automatic tuning method. | Weak signal or loose antenna connections. | Tighten the AM loop antenna connections and rotate it for best reception. Use the manual tuning method. |
| | There are continuous crackling and hissing noises. | Noises result from lightning, fluorescent lamps, motors, thermostats and other electrical equipment. | Use an outdoor antenna and a ground wire. This will help somewhat but it is difficult to eliminate all the noises. |
| | There are buzzing and whining noises (especially in the evening). | A television set is being used nearby. | Relocate this unit away from the TV. |
| Remote control Transmitter | The remote control transmitter does not work. | Direct sunlight or lighting (of an inverter type of fluorescent lamp etc.) is striking the remote control sensor of the main unit. | Change the position of the main unit. |
| | | The batteries of this remote control transmitter are too weak. | Replace the batteries with new ones. |
| Others | The sound is degraded when listening with the headphones connected to the compact disc player or cassette deck that is connected with this unit. | This unit is in the standby mode. | Turn the power to this unit on. |

SPECIFICATIONS

AUDIO SECTION

| | |
|---|--|
| Minimum RMS Output Power per Channel | |
| Main L, R | 8 ohms, 20 Hz to 20 kHz, 0.04% THD50W+50W |
| Center | 8 ohms, 1 kHz, 0.04% THD.....50W |
| Rear | 8 ohms, 1 kHz, 0.04% THD.....20W |
| Maximum Power (EIAJ) [China and General models only] | |
| 8 ohms, 1 kHz, 10% THD | |
| Main L, R |75W+75W |
| Center |75W |
| Rear |30W |
| Dynamic Power per Channel | |
| (by IHF Dynamic Headroom measuring method) | |
| 8/6/4/2 ohms | |
| [U.S.A. and Canada models] |80/95/120/140W |
| [Europe, Australia, China and General models] |80/100/120/135W |
| DIN Standard Output Power per Channel [Europe model only] | |
| 4 ohms, 1 kHz, 0.7% THD |75W |
| Dynamic Headroom (8 ohms) [U.S.A. and Canada models only] |2.04 dB |
| IEC Power [Europe model only] | |
| 8 ohms, 1 kHz, 0.1% THD |60W |
| Power Band Width | |
| 8 ohms, 25W, 0.1% THD |10 Hz to 50 kHz |
| Damping Factor | |
| 8 ohms, 20 Hz to 20 kHz |50 or more |
| Input Sensitivity/Impedance | |
| PHONO MM |2.5 mV/50 k-ohms |
| CD/TAPE-MD/VIDEO/VCR |150 mV/50 k-ohms |
| Maximum Input Signal | |
| PHONO MM | |
| 1 kHz, 0.5% THD |100 mV |
| CD/TAPE-MD/VIDEO/VCR (EFFECT OFF) | |
| 1 kHz, 0.5% THD |2.5V |
| Output Level/Impedance | |
| REC OUT |150 mV/2.5 k-ohms |

| | |
|--|----------------------|
| Headphones Jack Rated Output/Impedance | |
| Output Level (8 ohms, 0.04% THD) |0.45V |
| Impedance |330 ohms |
| Frequency Response (20 Hz to 20 kHz) | |
| CD/TAPE-MD/VIDEO/VCR |0±0.5 dB |
| RIAA Equalization Deviation | |
| PHONO MM |0±0.5 dB |
| Total Harmonic Distortion (20 Hz to 20 kHz) | |
| PHONO MM to REC OUT | |
| 1V |0.02% |
| CD/TAPE-MD/VIDEO/VCR to SP OUT | |
| 30W/8 ohms |0.03% |
| Signal-to-Noise Ratio (IHF-A Network) | |
| PHONO MM to REC OUT | |
| (5 mV Input Shorted) |80 dB |
| CD/TAPE-MD/VIDEO/VCR to SP OUT | |
| (Shorted) |93 dB |
| Residual Noise (IHF-A Network) | |
| MAIN L/R |140 µV |
| Channel Separation (Vol. -30 dB, EFFECT OFF) | |
| PHONO MM | |
| (Input Shorted, 1 kHz) |60 dB |
| CD/TAPE-MD/VIDEO/VCR | |
| (Input 5.1 k-ohms Terminated, 1 kHz) |60 dB |
| Tone Control Characteristics | |
| BASS: Boost/cut |±10 dB (50 Hz) |
| Turnover Frequency |350 Hz |
| TREBLE: Boost/cut |±10 dB (20 kHz) |
| Turnover Frequency |3.5 kHz |
| Gain Tracking Error (0 to -60 dB) |3 dB |

VIDEO SECTION

| | |
|---|------------------------|
| Video Signal Level |1 Vp-p/75 ohms |
| Maximum Input Level |1.5 Vp-p or more |
| Signal-to-Noise Ratio |50 dB or more |
| Monitor Out Frequency Response | |
|5 Hz to 10 MHz, -3 dB | |
| FM SECTION | |
| Tuning Range | |
| [U.S.A. and Canada models] |87.5 to 107.9 MHz |
| [Europe, Australia, China and General models] |87.5 to 108.0 MHz |

| | |
|--|-------------------------|
| 50 dB Quieting Sensitivity (IHF, 75 ohms) | |
| [U.S.A., Canada, Australia, China and General models only] | |
| Mono |1.55 µV (15.1 dBf) |
| Stereo |21 µV (37.7 dBf) |
| Usable Sensitivity (75 ohms) | |
| [Europe and Australia models only] | |
| DIN, Mono (S/N 26 dB) |0.9 µV |
| DIN, Stereo (S/N 46 dB) |24 µV |
| Image Response Ratio | |
| [U.S.A., Canada, China and General models] |45 dB |
| [Europe and Australia models] |80 dB |
| IF Response Ratio | |
| [U.S.A., Canada, China and General models] |70 dB |
| [Europe and Australia models] |80 dB |
| Spurious Response Ratio |70 dB |
| AM Suppression Ratio | |
| [U.S.A., Canada, China and General models] |55 dB |
| [Europe and Australia models] |50 dB |
| Capture Ratio |1.5 dB |
| Alternate Channel Selectivity | |
| [U.S.A., Canada, China and General models only] |85 dB |
| Selectivity (two signals, 40 kHz Dev. ±300 kHz) | |
| [Europe and Australia models only] |70 dB |
| Signal-to-Noise Ratio (IHF) Mono/Stereo | |
| [U.S.A., Canada, China and General models] |80 dB/75 dB |
| (DIN-Weighted, 40 kHz Dev.) Mono/Stereo | |
| [Europe and Australia models] |75 dB/70 dB |
| Harmonic Distortion (1 kHz) | |
| [U.S.A., Canada, Australia, China and General models] | |
| Mono/Stereo |0.1/0.2% |
| [Europe model] | |
| Mono/Stereo (40 kHz Dev.) |0.1/0.2% |
| Stereo Separation (1 kHz) | |
| [U.S.A., Canada, Australia, China and General models] |50 dB |
| [Europe model (40 kHz Dev.)] |50 dB |
| Frequency Response | |
| 20 Hz to 15 kHz |0 ±1.5 dB |

AM SECTION

| | |
|--|------------------|
| Tuning Range | |
| [U.S.A., Canada, China and General models] | 530 to 1,710 kHz |
| [Europe and Australia models] | 531 to 1,611 kHz |
| Usable Sensitivity | 100 μ V/m |
| Selectivity | 32 dB |
| Signal-to-Noise Ratio | 50 dB |
| Image Response Ratio | 40 dB |
| Spurious Response Ratio | 50 dB |
| Harmonic Distortion (1 kHz) | 0.3% |

AUDIO SECTION

| | |
|---|-------------------|
| Output Level/Impedance | |
| FM (100% mod., 1 kHz) | |
| [U.S.A., Canada, Australia, China and General models] | 500 mV/2.2 k-ohms |
| [Europe model (40 kHz Dev.)] | 400 mV/2.2 k-ohms |
| AM (30% mod., 1 kHz) | |
| | 150 mV/2.2 k-ohms |

GENERAL

| | |
|--|-------------------------------|
| Power Supply | |
| [U.S.A. and Canada models] | AC 120V, 60 Hz |
| [Europe model] | AC 230V, 50 Hz |
| [Australia model] | AC 240V, 50 Hz |
| [China and General models] | AC 110/120/220/240V, 50/60 Hz |
| Power Consumption | |
| [U.S.A. model] | 190W |
| [Canada model] | 210W |
| [Europe, Australia, China and General models] | 200W |
| Maximum Power Consumption [General model only] (8 ohms, 1 kHz, 10% THD, When 4 channels are driven:) | 410W |

AC Outlets

| | |
|--|---|
| 2 SWITCHED OUTLETS | |
| [U.S.A., Canada, Europe, China and General models] | 100W max. total |
| 1 SWITCHED OUTLET | |
| [Australia model] | 100W max. total |
| Dimensions (W x H x D) | |
| | 435 x 151 x 345 mm (17-1/8" x 5-15/16" x 13-9/16") |

| | |
|-------------|---|
| Weight | 8.0 kg (17 lbs. 10 oz.) |
| Accessories | Indoor FM antenna AM loop antenna Remote control transmitter Batteries Antenna adapter (U.S.A. and Canada models only) |

Specifications are subject to change without notice.



YAMAHA ELECTRONICS CORPORATION, USA 6660 ORANGETHORPE AVE., BUENA PARK, CALIF. 90620, U.S.A.
YAMAHA CANADA MUSIC LTD. 135 MILNER AVE., SCARBOROUGH, ONTARIO M1S 3R1, CANADA
YAMAHA ELECTRONIK EUROPA G.m.b.H. SIEMENSSTR. 22-34, 25462 RELLINGEN BEI HAMBURG, F.R. OF GERMANY
YAMAHA ELECTRONIQUE FRANCE S.A. RUE AMBROISE CROIZAT BP70 CROISSY-BEAUBOURG 77312 MARNE-LA-VALLEE CEDEX02, FRANCE
YAMAHA ELECTRONICS (UK) LTD. YAMAHA HOUSE, 200 RICKMANSWORTH ROAD WATFORD, HERTS WD1 7JS, ENGLAND
YAMAHA SCANDINAVIA A.B. J A WETTERGRENS GATA 1, BOX 30053, 400 43 VÄSTRA FRÖLUNDA, SWEDEN
YAMAHA MUSIC AUSTRALIA PTY, LTD. 17-33 MARKET ST., SOUTH MELBOURNE, 3205 VIC., AUSTRALIA

YAMAHA CORPORATION
Printed in China  V212240